



Deep Drawn 1 Compartment Drop-In Sink

Drop In Sinks

Certifications:



Features:

- Deep Drawn Construction for a seamless and more appealing design
- Traditional Top Mount
- Includes BKDR-4 Drain
- Faucet Holes 4" O.C.

Material:

- T-304 18 ga. Stainless Steel

Options:

- Upgrade to OptiFlow Heavy Duty Faucets or Evolution Stainless Steel Faucets
- Wrist Blades
- "-P-G" Includes BKD-8G-G Lead-Free Faucet

Part Number	Unit Size (l x w x d)	Bowl Size (l x w x d)	Included Faucet
DDI-2016824	21" x 23" x 8" (d)	20" x 16" x 8" (d)	-
DDI-2016824-P-G	21" x 23" x 8" (d)	20" x 16" x 8" (d)	BKD-8G-G

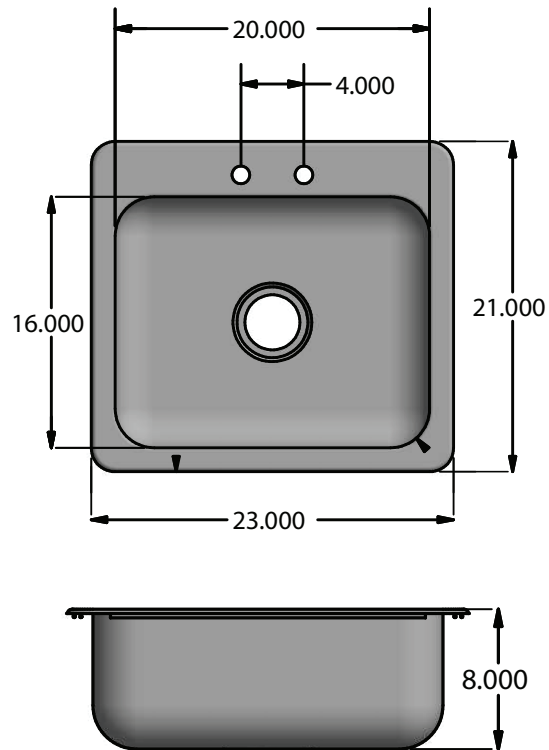
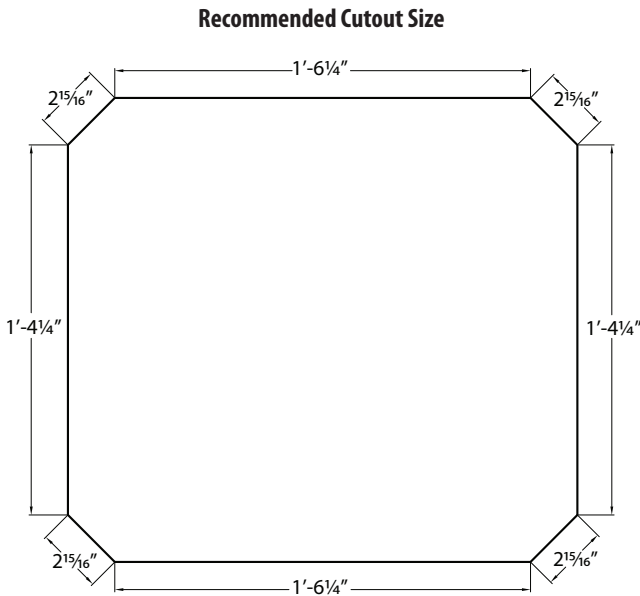

PRODUCT DATA SHEET

BK RESOURCES

