

Sunkist Sectionizer Jr.

For safely preparing fresh-cut
wedges, slices and halves

NEW!

**Color-Coded
Blade Cups/Plungers**



- Quick & easy cleanup – dishwasher safe parts
- Uniform pieces for appealing presentation
- Listed by NSF International
- Interchangeable blade cups – 9 different ones

**Available from your
foodservice equipment dealer**

Contact us for the one nearest you:

800.383.7141 • fax 909.822.2125

Foodservice Equipment Sales, Sunkist Growers
10509 Business Dr., Unit B, Fontana, CA 92337

foodservice.sunkist.com/equipment

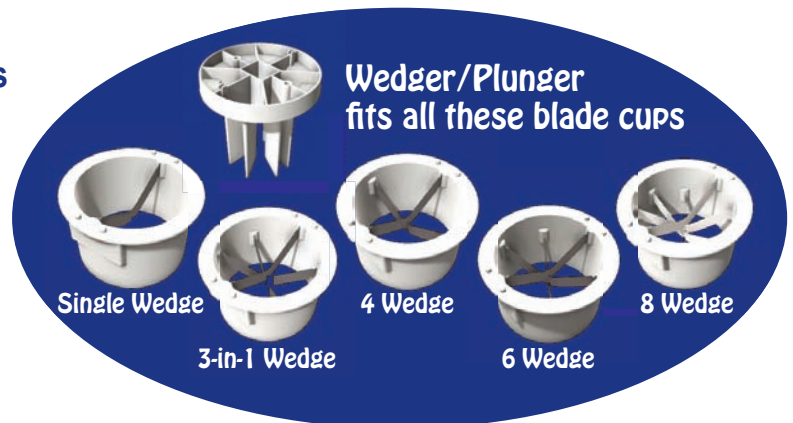

Part Number Description

- B-1 Container - 2.7 Quart
- B-2 Lid - 2.7 Quart
- B-3 2.7 Quart Assembly - Container & Lid (B-1 & B-2)
- B-4 Cup Holder
- B-5 Plunger Assembly
- S-3B Blade Cup w/cover (6 wedge) (fits S-9)
- S-4B Blade Cup w/cover (6 slice) (fits S-10)
- S-5B Blade Cup w/cover (4 wedge) (fits S-9)
- S-6 Wedger Cup cover (sold w/S-3, S-5, S-29, S-30, S-32, S-35)
- S-7 Slicer Cup cover (sold w/S-4)
- S-9 Plunger Wedger (fits parts S-3, S-5, S-29, S-30, S-35)
- S-10 Plunger Slicer fits part S-4 only
- S-11C Brass Knob
- S-11D Brass Stud
- S-15 7 Slice serrated Blade Cup w/cover (fits S-16)
- S-16 Plunger Tomato Slicer (fits S-15)
- S-17 Tomato Set (S-15 & S-16)
- S-19 Wedger Cup Cover (10-wedge) (sold w/S-20)
- S-20B Blade Cup w/cover (10-wedge) (fits S-21)
- S-21 Plunger (fits S-20)
- S-22 10 Wedge Set (S-20 & S-21)
- S-29B Blade Cup w/cover (8 wedge) (fits S-9)
- S-30B Blade Cup w/cover (3-in-1) (fits S-9)
- S-32B Apple Corer Cup (fits S-33)
- S-33 Apple Plunger (fits S-32)
- S-34 Apple Corer Set (S-32 & S-33)
- S-35B Single Blade Cup w/cover (fits S-9)

Sunkist

Sectionizer Jr.

Parts Information



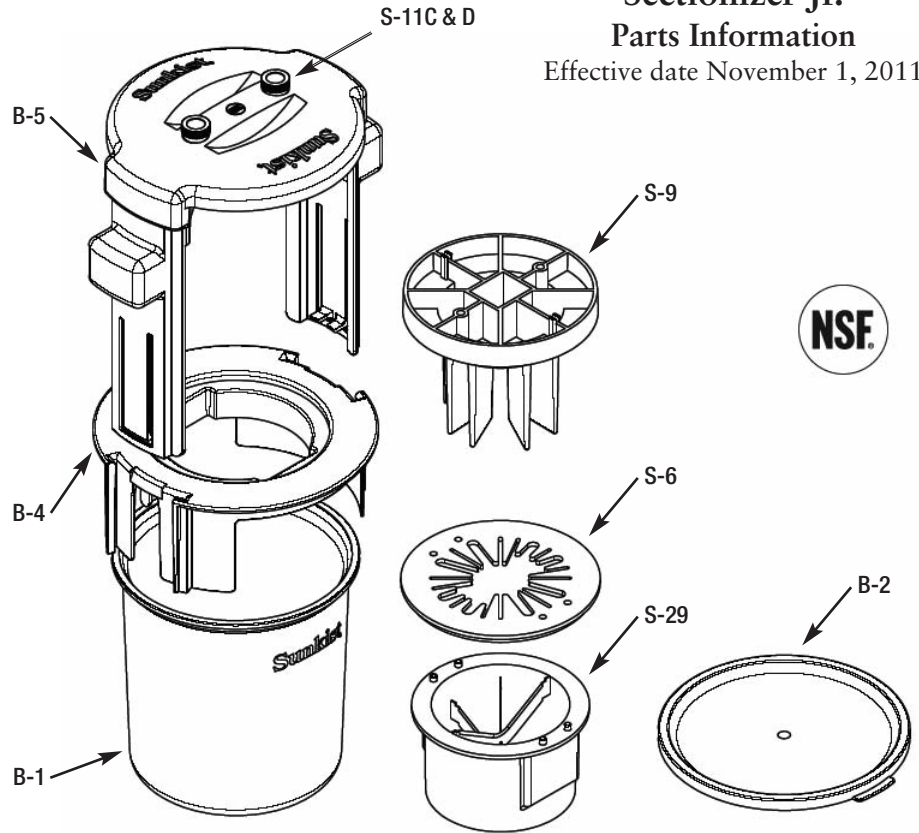





Effective date November 1, 2011



Complete Sectionizer Jr. Model #

Blade Cup Style

Description

Complete Sectionizer Jr. Model #	Blade Cup Style	Description
B-200		Basic Unit (No Plunger and No Blade Cup).
B-201	 4 Wedge	4 evenly spaced and cut wedges.
B-202	 6 Wedge	6 evenly spaced and cut wedges.
B-203	 6 Slice	6 slices 5/16" thick. Must use plunger S-10.
B-204	 8 Wedge	8 evenly spaced and cut wedges.
B-205	 3-in-1	2 halves scored in 3 wedges each (for school foodservice).
B-206	 Apple Model	6 evenly spaced and cut wedges with center core removed. Must use plunger #33.
B-207	 Single	Cuts fruit & vegetables in half.
B-209	 Tomato Model	7 evenly spaced slices. Must use plunger S-16.
B-210	 10 Wedge	10 evenly spaced and cut wedges.

Specifications

Safe...Listed by NSF International.
 Overall Dimensions9½" high, 9½" wide, 7¾" deep
 Net Weight4 pounds
 Shipping Weight5 pounds
 Volume0.47 cu.ft.
 Carton Size10" high, 10" wide, 8" deep

Additional Containers & Lids Available

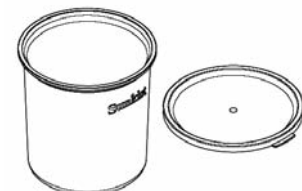

B-3. 2.7 Quart Assembly – Container & Lid (B-1 & B-2)

Overall Dimensions7" high, 7" wide
 Shipping Weight1½ pounds