

DESIGNER LINE SANDWICH UNIT

Model: D48N8C-FB-D

Natural Refrigerant R-290 Model

Designer Line

48" Cutting Top Sandwich Unit
Refrigerator with Drawers - 8 Pans
Front Breathing

Stainless steel front, top and end panels and interior.



Options and Accessories

(upcharge and lead times may apply)

Stainless steel back	Composite cutting board
Overshelves (single or double)	Flat insulated night cover
Drawer locks	Vision panel lid
Rear-mounted cutting board	Modified pan openings

Consult factory for other model configurations, options and accessories.

Project Name:

Model Specified:

Location:

Item No:

Quantity:

AIA #:

SIS #:

Standard Model Features

REFRIGERATION SYSTEM

Performance-rated refrigeration system

Natural, environmentally-safe, high-efficiency R-290 refrigerant¹

Unique air flow distribution allows pan product to maintain 33° - 41°F

Automatic, hot gas condensate evaporator

Non-corrosive, plasticized fin evaporator coil

Easily serviceable, back mounted compressor

Expansion valve system

CABINET ARCHITECTURE

2" non-CFC polyurethane foam insulation

Smooth, polished chrome drawer handles

Stainless steel roll-out drawers

Magnetic snap-in drawer gaskets

19" deep, full length nylon cutting board

Insulated lid

Completely enclosed, vented and removable case back

3 3/4" casters

MODEL FEATURES

(8) 1/6 size recessed pans, 4" deep

Removable interior tub below pans

Electronic controller w/digital display & hi-low alarm

¹ R-290 refrigerant meets all federal and state regulatory requirements.

Front breathers are a unique, field assembled, bottom mounted ventilation system designed to allow cabinets to be flush against a wall or built into a counter to conserve space. For proper operation, the area under and in front of the cabinet must not be obstructed in any way.

Continental[®]
Refrigerator

Toll-Free: 800-523-7138
Phone: 215-244-1400
Fax: 215-244-9579

539 Dunksferry Road
Bensalem, PA 19020
www.continentalrefrigerator.com

APPROVAL:

Model Specifications

DIMENSIONAL DATA

Net Capacity (cu. ft.)	13.4 (379 cu l)
1/6 Size Pans (4" deep)	8
Width, Overall (in.)	48 (1219 mm)
Depth, Overall (in.) (incl. cutting board & bumpers)	38 1/4 (972 mm)
Depth, Cutting Board (in.)	19 (483 mm)
Height, Overall (in.) (incl. 3 3/4" casters)	41 (1041 mm)
No. of Drawers	4

REFRIGERANT DATA

Condensing Unit Size (H.P.)	1/4+
Capacity (BTU/Hr)*	1940

ELECTRICAL DATA

Voltage (int'l)	115/60/1 (220/50/1)
Total Amps (int'l)	4.5 (3.6)
10 ft. Cord/Plug [attached] (int'l)	Yes (No)

SHIPPING DATA

Weight (lbs.)	267 (121 kg)
Height - Crated (in.)	43 1/4 (1099 mm)
Width - Crated (in.)	56 (1422 mm)
Depth - Crated (in.)	37 1/4 (946 mm)

DRAWER PAN CONFIGURATIONS

Two Tier: (1) 1/2 size x 6 & (1) 1/3 x 6 pan per drawer

* Rating @ +25°F evaporator, 90°F ambient

Figures in parentheses reflect metric equivalents rounded to the nearest whole unit.



Equipped with one NEMA-5-15P Plug
(varies by country)

Continental
Refrigerator

Toll-Free: 800-523-7138
Phone: 215-244-1400
Fax: 215-244-9579

539 Dunkserry Road
Bensalem, PA 19020
www.continentalrefrigerator.com

Due to our continued efforts in developing innovative products, specifications subject to change without notice.



MADE IN THE U.S.A.

© Copyright 2020. Continental Refrigerator.
A Division of National Refrigeration & Air Conditioning Products, Inc.

Model Plan Views

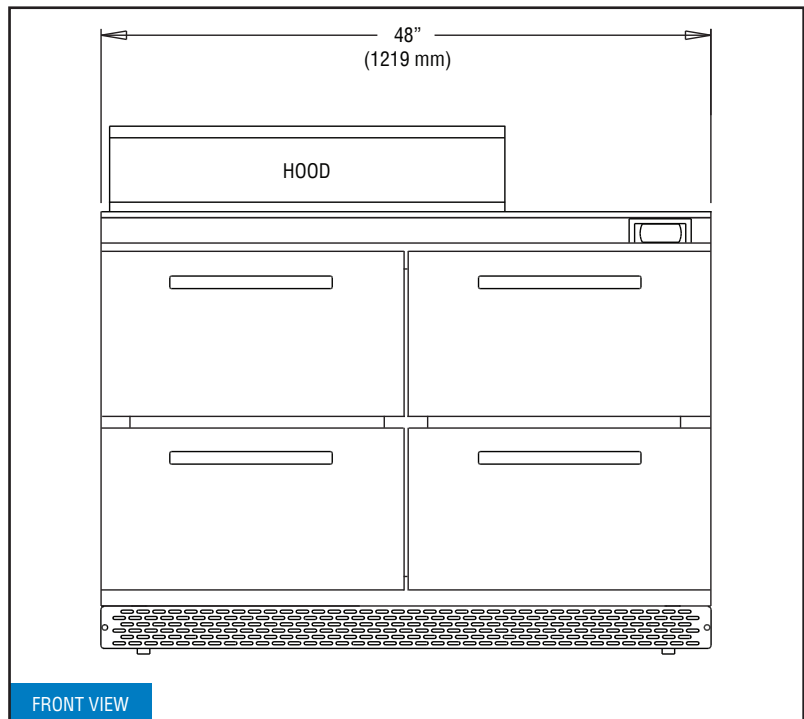

FRONT VIEW

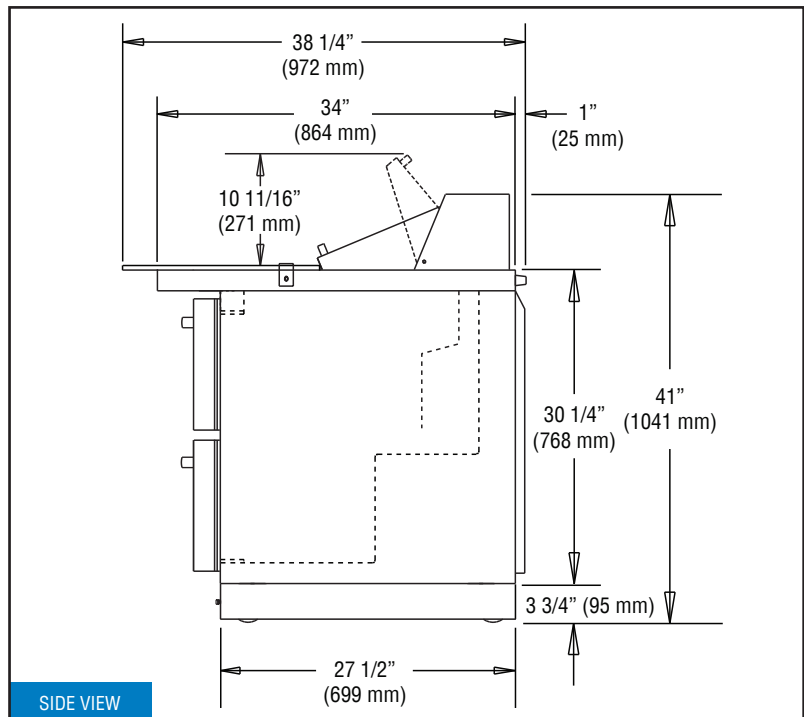

SIDE VIEW

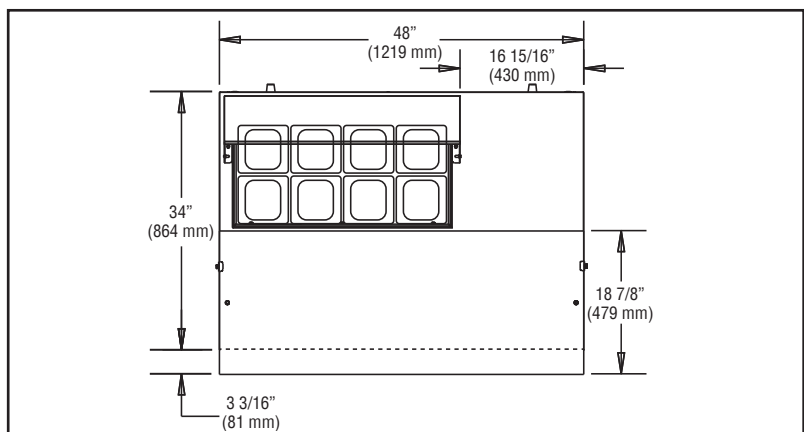

PAN TOP CONFIGURATION

D48N8C-FB-D (4/27/20)