

DESIGNER LINE BASE MODEL

Model: DRA93NSS-D

Natural Refrigerant R-290 Model



93" Base Worktop Refrigerator with Drawers

Heavy gauge #300 Series stainless steel top, stainless steel front, end panels and interior, galvanized steel rear and grill.



Options and Accessories

(upcharge and lead times may apply)

| | |
|--------------------------------|---|
| Stainless steel back | Front breathing |
| Overshelves (single or double) | Drawer in lieu of door section above the condensing unit* |
| Casters | Condensing unit left (standard on right) |
| Door/drawers locks | |

Consult factory for other model configurations, options and accessories.

*Drawer section above condensing unit holds (1) 12 x 20 x 6 pan.

Project Name:

Model Specified:

Location:

Item No:

Quantity:

AIA #:

SIS #:

Standard Model Features

REFRIGERATION SYSTEM

Performance-rated refrigeration system

Natural, environmentally-safe, high-efficiency R-290 refrigerant¹

Unique forced air design utilizes fans (approx. every 12") across the entire back of unit for even distribution of cold

Automatic, hot gas condensate evaporator

Non-corrosive, plasticized fin evaporator coil

Easily serviceable, back mounted compressor

Expansion valve system

CABINET ARCHITECTURE

2" non-CFC polyurethane foam insulation

Smooth, polished chrome drawer/door handles

Spring loaded, self closing door (over condensing unit)

Magnetic snap-in drawer/door gaskets

Stainless steel roll-out drawers

Completely enclosed, vented and removable rear and side grills

6" adjustable stainless steel legs

MODEL FEATURES

Electronic controller w/digital display & hi-low alarm

Electronic control, off-cycle defrost

Refrigerated section w/door above the condensing unit

Field rehingeable door (over condensing unit)

¹ R-290 refrigerant meets all federal and state regulatory requirements.

NOTE: Models come standard with a door over the condensing unit. A drawer over the condensing unit is an option.



Toll-Free: 800-523-7138
Phone: 215-244-1400
Fax: 215-244-9579

539 Dunksferry Road
Bensalem, PA 19020
www.continentalrefrigerator.com

APPROVAL:

Model Specifications

DIMENSIONAL DATA

| | |
|---|------------------|
| Net Capacity (cu. ft.) | 32 (906 cu l) |
| Width, Overall (in.) | 93 (2362 mm) |
| Depth, Overall (in.) (incl. handles & bumpers) | 36 5/16 (922 mm) |
| Height, Overall (in.) (incl. 6" legs) | 36 (914 mm) |
| No. of Drawers | 6 |
| No. of Half Doors | 1 |
| Interior Depth (in.) (above condenser) | 30 (762 mm) |
| Interior Height (in.) (above condenser) | 12 1/2 (318 mm) |
| Interior Width (in.) (above condenser) | 17 (432 mm) |

REFRIGERANT DATA

| | |
|-----------------------------|------|
| Condensing Unit Size (H.P.) | 1/4+ |
| Capacity (BTU/Hr)* | 5260 |

ELECTRICAL DATA

| | |
|-------------------------------------|---------------------|
| Voltage (int'l) | 115/60/1 (220/50/1) |
| Total Amps (int'l) | 5.1 (2.4) |
| 10 ft. Cord/Plug [attached] (int'l) | Yes (No) |

SHIPPING DATA

| | |
|-----------------------|------------------|
| Weight (lbs.) | 595 (270 kg) |
| Height - Crated (in.) | 43 3/4 (1111 mm) |
| Width - Crated (in.) | 95 (2413 mm) |
| Depth - Crated (in.) | 47 (1194 mm) |

DRAWER PAN CONFIGURATIONS

Two Tier: (2) 12 x 20 x 6 pans per drawer

* Rating @ +25°F evaporator, 90°F ambient

Figures in parentheses reflect metric equivalents rounded to the nearest whole unit.



Equipped with one NEMA-5-15P Plug
(varies by country)

Model Plan Views

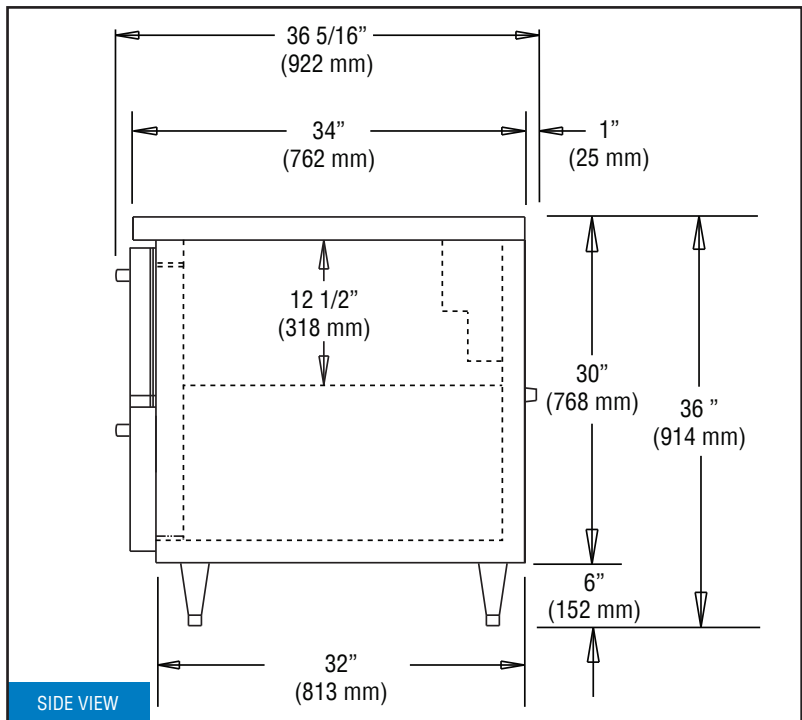
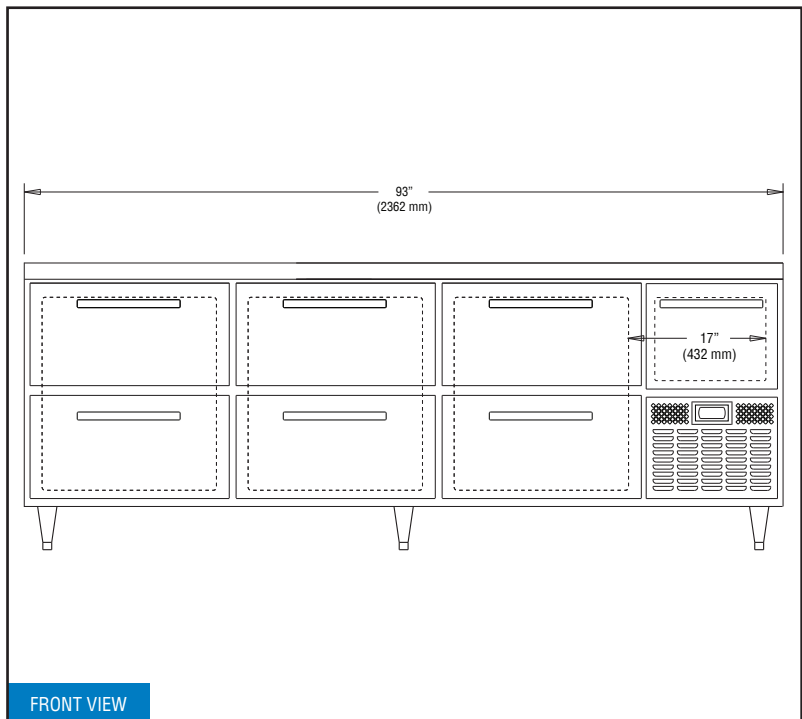

IMPORTANT NOTE: If the cabinet is located directly against a wall, a minimum clearance of 3" is required on sides, front and rear.

Continental
Refrigerator

Toll-Free: 800-523-7138
Phone: 215-244-1400
Fax: 215-244-9579

539 Dunkserry Road
Bensalem, PA 19020
www.continentalrefrigerator.com

Due to our continued efforts in developing innovative products, specifications subject to change without notice.



MADE IN THE U.S.A.

© Copyright 2019. Continental Refrigerator.
A Division of National Refrigeration & Air Conditioning Products, Inc.

DRA93NSS-D (6/15/19)